

# POP-A-SHOT®

## CLASSIC OWNER'S MANUAL



SKU# PASCLAS19-02

[WWW.POP-A-SHOT.NET](http://WWW.POP-A-SHOT.NET)

## IMPORTANT SAFETY INSTRUCTIONS

**STOP**

**Read all instructions:** All the safety and operating instructions should be read carefully before this product is operated or played.

**Caution:** This is not a toy and is intended for use by or under the supervision of adults. Adults should review safety guidelines with children to avoid possible risk of electric shock or other injuries.

**Recommend:** The game should be periodically examined for conditions that may result in the risk of fire, electrical shock or injury to persons. In the event such conditions exist, the game should not be used until properly repaired.

**Storage:** This product is made from wood-based components and is sensitive to extreme temperatures and moisture/humidity. Subject to these conditions will affect game play, appearance and longevity.

- Remove all the parts from the box and verify that you have all of the listed parts as shown on the parts list page.
- Find a clean, level place to begin assembling your Pop-A-Shot game.
- Like most things in life, putting together your Pop-A-Shot is better when done with a friend.

### TOOLS

#### Required

- Nylon head mallet (Not included)
- 9/6" Wrench (Not included)
- 3/8" Drive ratchet (Not included)
- 9/16" Deep Well Socket (Not included)

#### Recommended

- Step ladder or stool

### A FEW NOTES BEFORE WE GET STARTED:

We hope you love your Pop-A-Shot and will let your friends and family (and any review sites) know how you feel. If you do have a problem (and it happens), please let us know first and give us a chance to fix it.

**EMAIL:** [popashot@popashot.net](mailto:popashot@popashot.net)

NOW LET'S PUT THIS THING TOGETHER







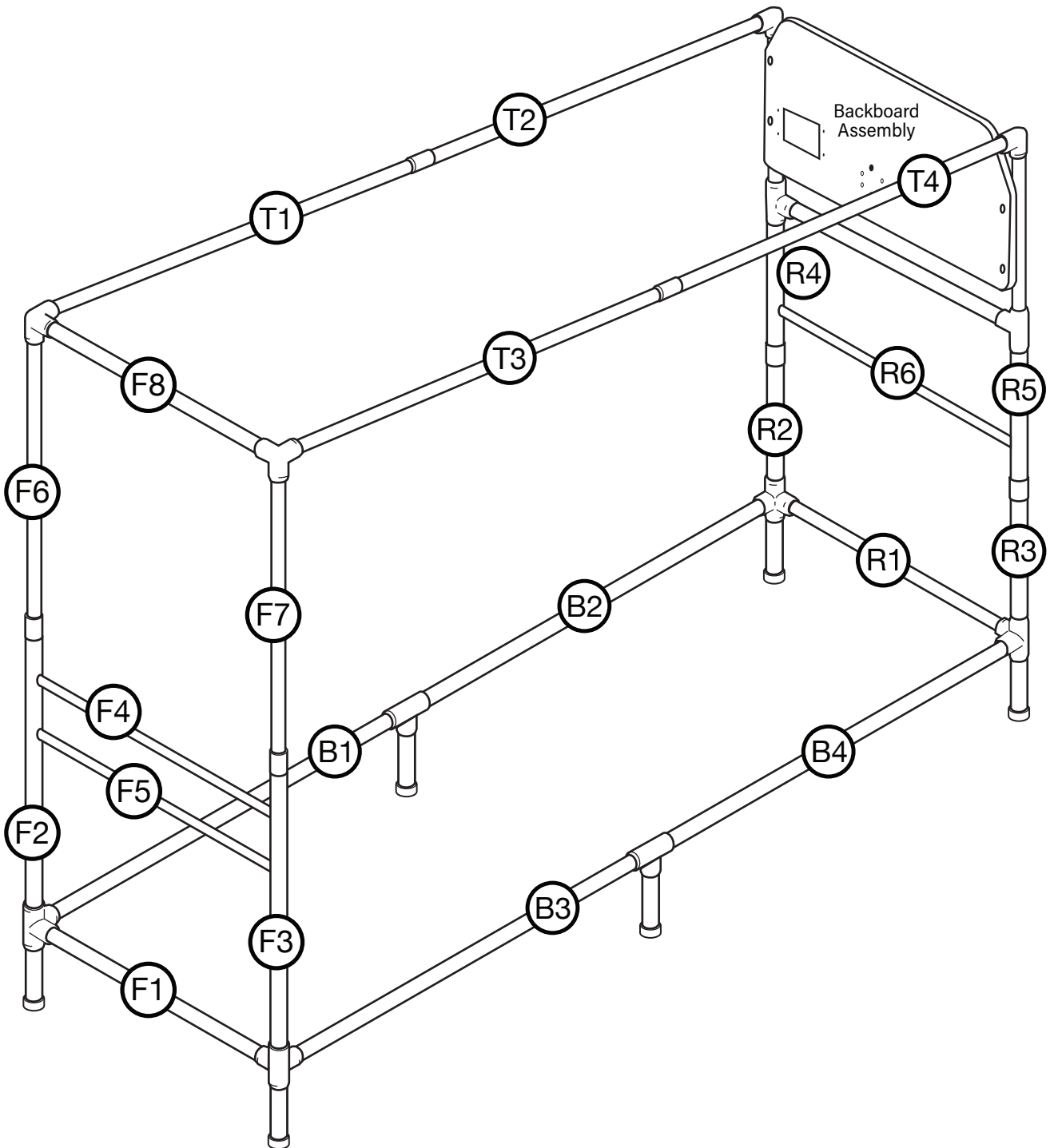



# POP-A-SHOT CLASSIC FRAME ASSEMBLY

ALL FRAME TUBE PARTS ARE LABELED

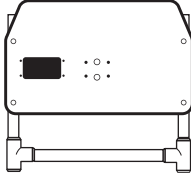
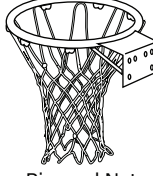
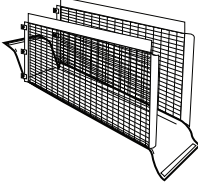
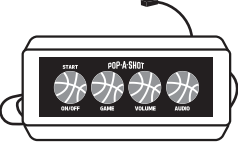
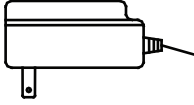

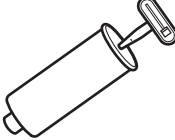
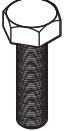

# PARTS LIST

 <p>Leg With Four-Way Joints 4x</p>	 <p>Leg With Two-Way Joints 2x</p>	 <p>Backboard Assembly</p>	 <p>Rim and Net 1x</p>	 <p>Ramp and Netting Set 1x</p>
 <p>Control Panel 1x</p>	 <p>AC Adapter 1x</p>	 <p>Balls 4x</p>	 <p>Bungee Ball Cord 14x</p>	 <p>Pump 1x</p>
 <p>Bolt 4x</p>	 <p>Nut 4x</p>	 <p>Wing Nut 4x</p>	 <p>Washer 4x</p>	

Inspect your box to make sure all parts are included

# STEP 1

## TO BUILD BOTTOM FRAME

Connect **B1** with **B2**, and **B3** with **B4** with **Tee Joints**.

Attach **4-Way Joints** to each end of assembled bottom frames. Add **Legs** to bottom frame.

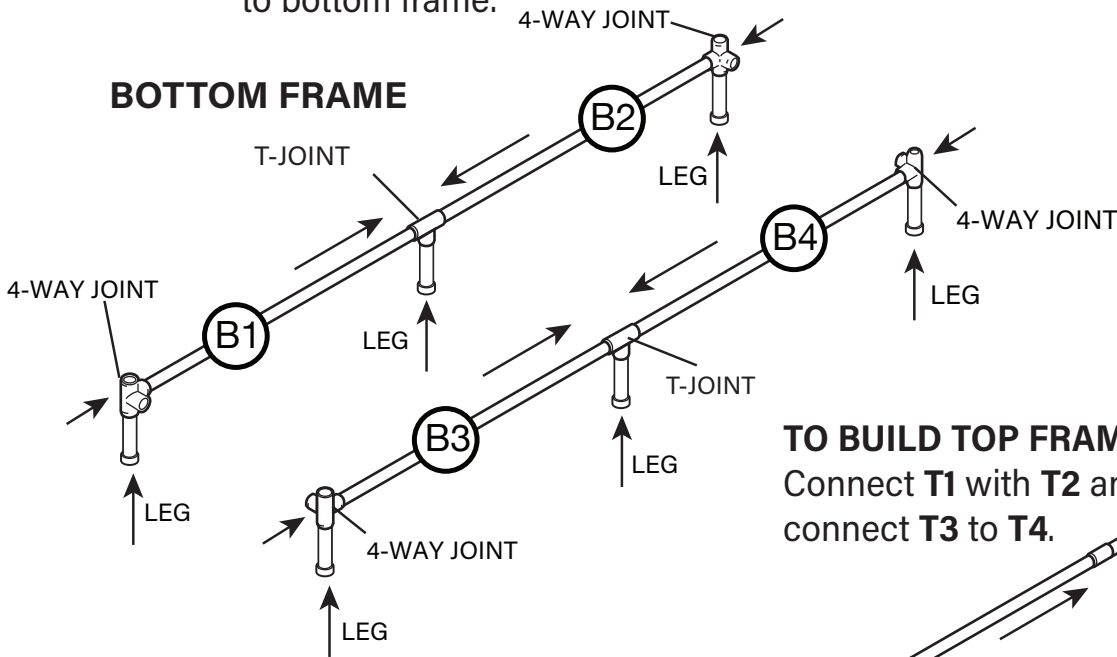

## TO BUILD TOP FRAME

Connect **T1** with **T2** and connect **T3** to **T4**.

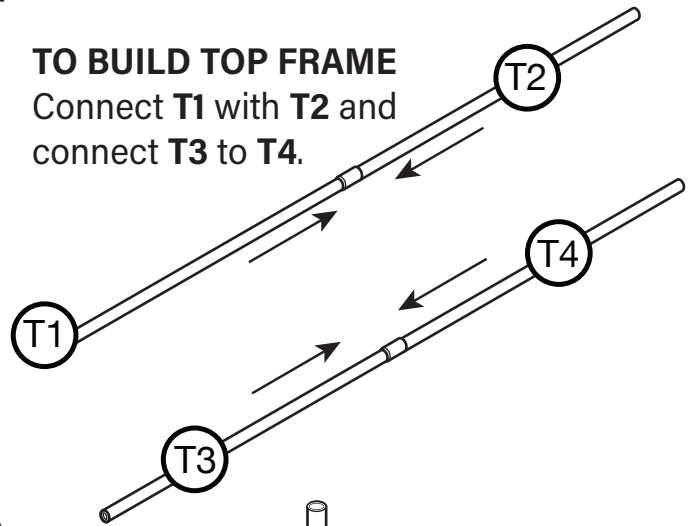

### Front

Connect **F2** vertically into **Four-Way Joint** on **B1**.  
 Connect **F3** vertically into **Four-Way Joint** on **B3**.  
 Connect **F1** horizontally into **Four-Way Joints** on **B1** and **B3**.

### Rear

Connect **R2** vertically into **Four-Way Joint** on **B2**.  
 Connect **R3** vertically into **Four-Way Joint** on **B4**.  
 Connect **R1** horizontally into **Four-Way Joints** on **B2** and **B4**.

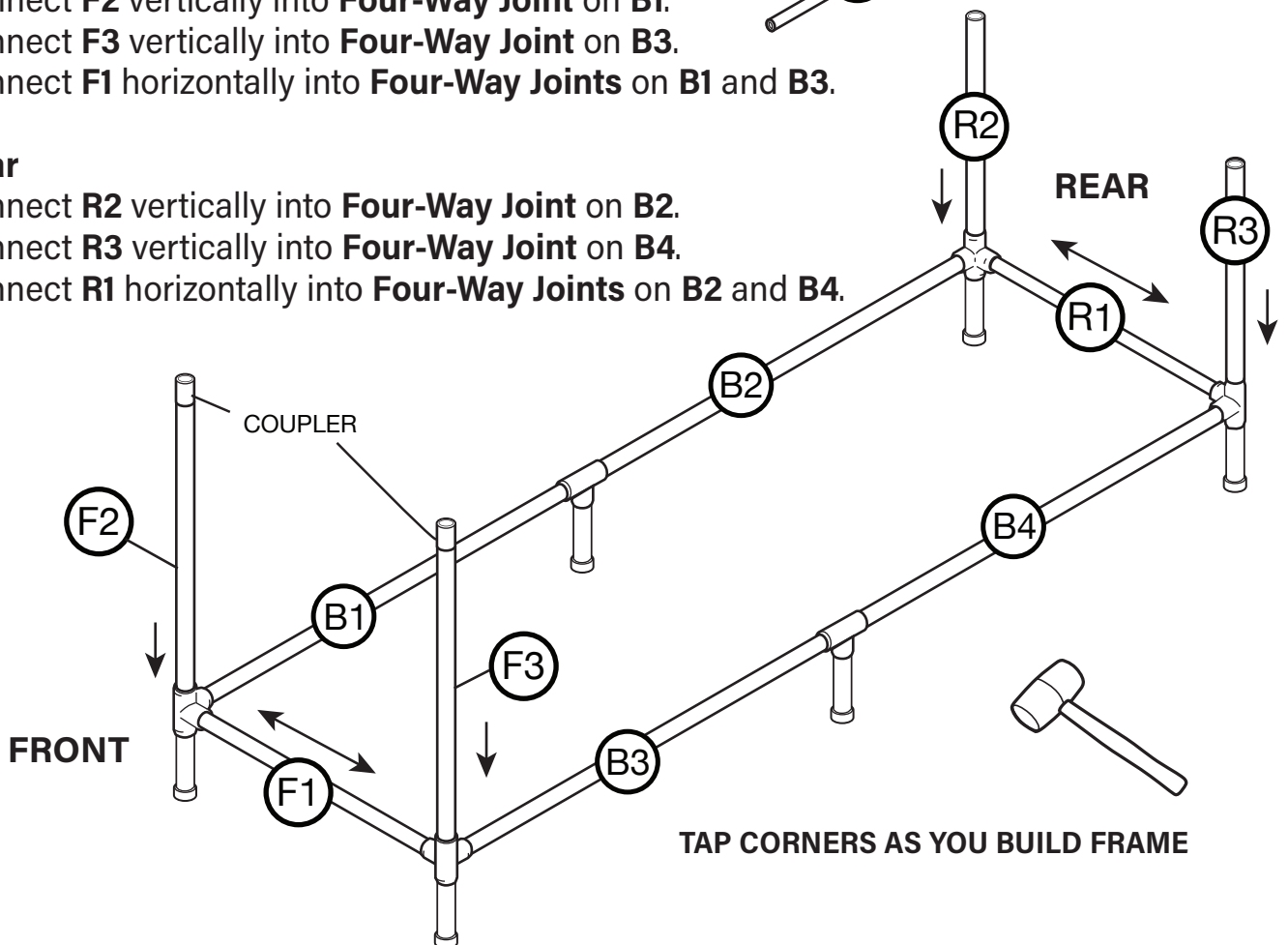

## STEP 2

### TO BUILD FRONT FRAME

Connect **F6** to **F2** (Left Side), using **Coupler**.

Connect **F7** to **F3** (Right Side), using **Coupler**.

Slide **F4** and **F5** into holes in **F2** and **F3**.

Connect **3-Way Elbows** to top of **F6** and **F7**.

Finish front frame with **F8**.

**TAP CORNERS AS YOU BUILD FRAME**

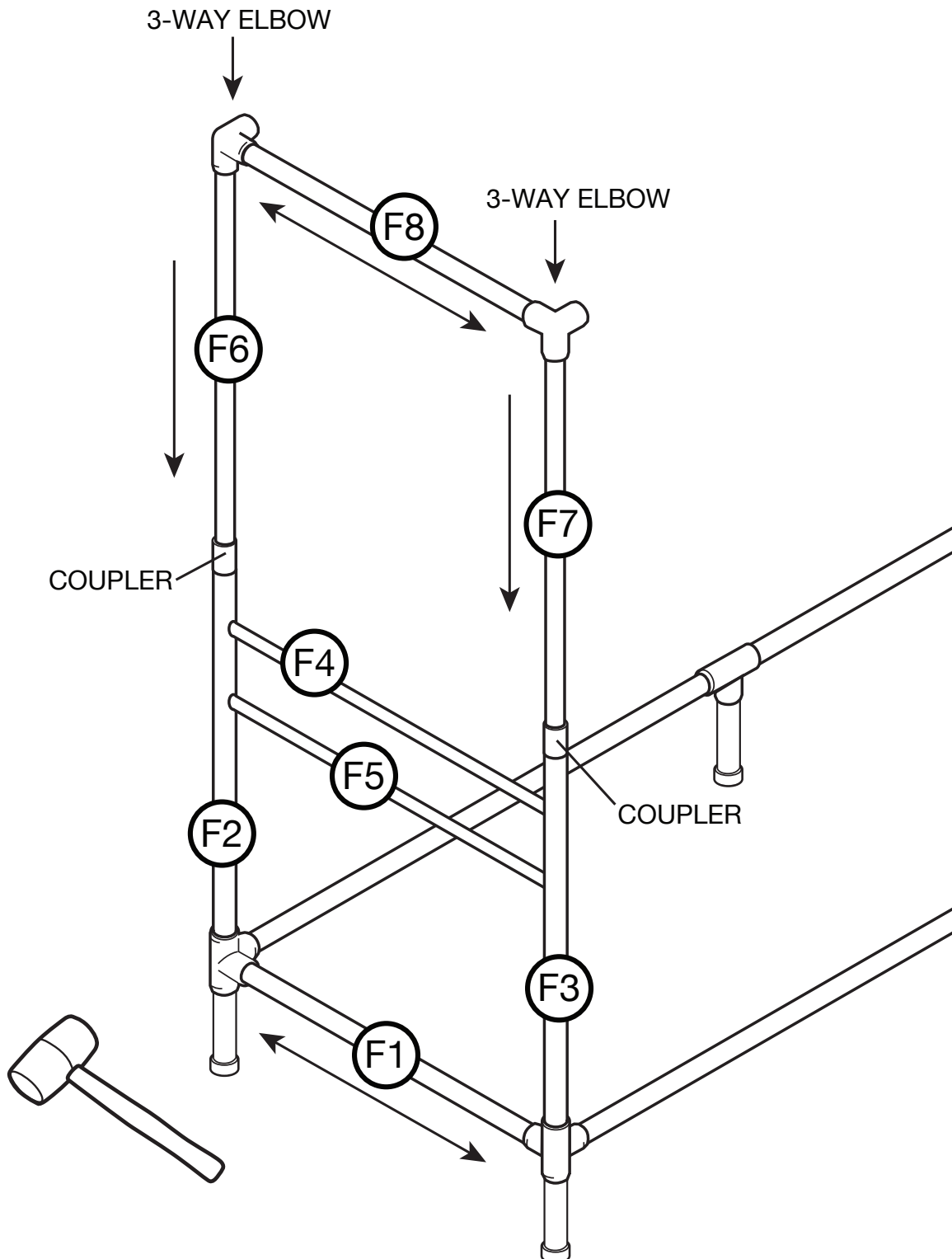

### **STEP 3** TO BUILD REAR FRAME

Connect **R3** to **R1**. Connect **R2** to **R1**. Connect **R4** to **R3** using **Coupler**. Connect **R5** to **R2** using **Coupler**. Slide **R6** in **R4** and **R5**. Attach **Backboard Assembly**.  
**TAP CORNERS AS YOU BUILD FRAME**

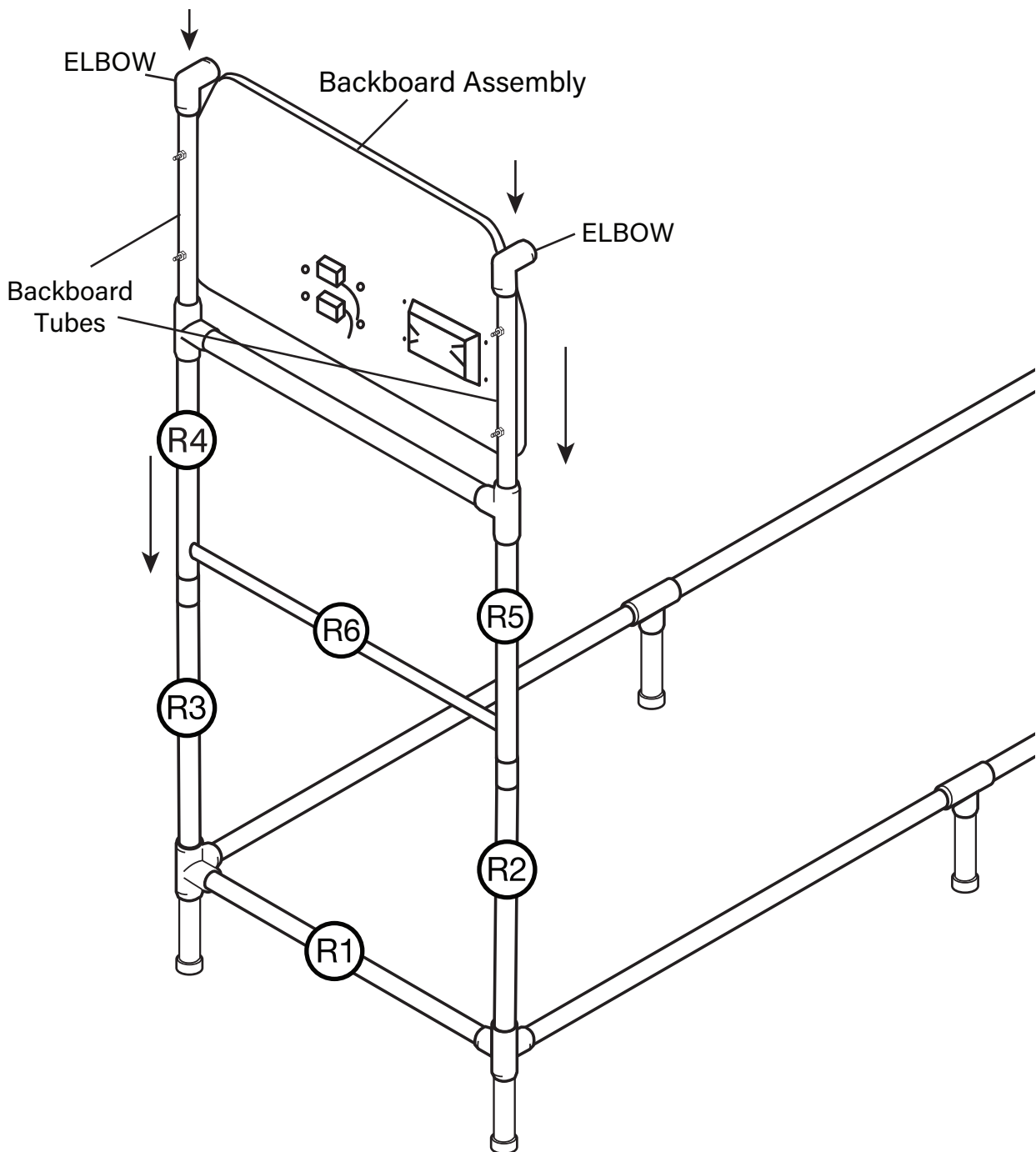

**STEP 4**

**ADD TOP FRAME**

Connect **T1, T2, T3** and **T4** to frame using **3-Way Elbows** on the front and **single elbows** on the rear.

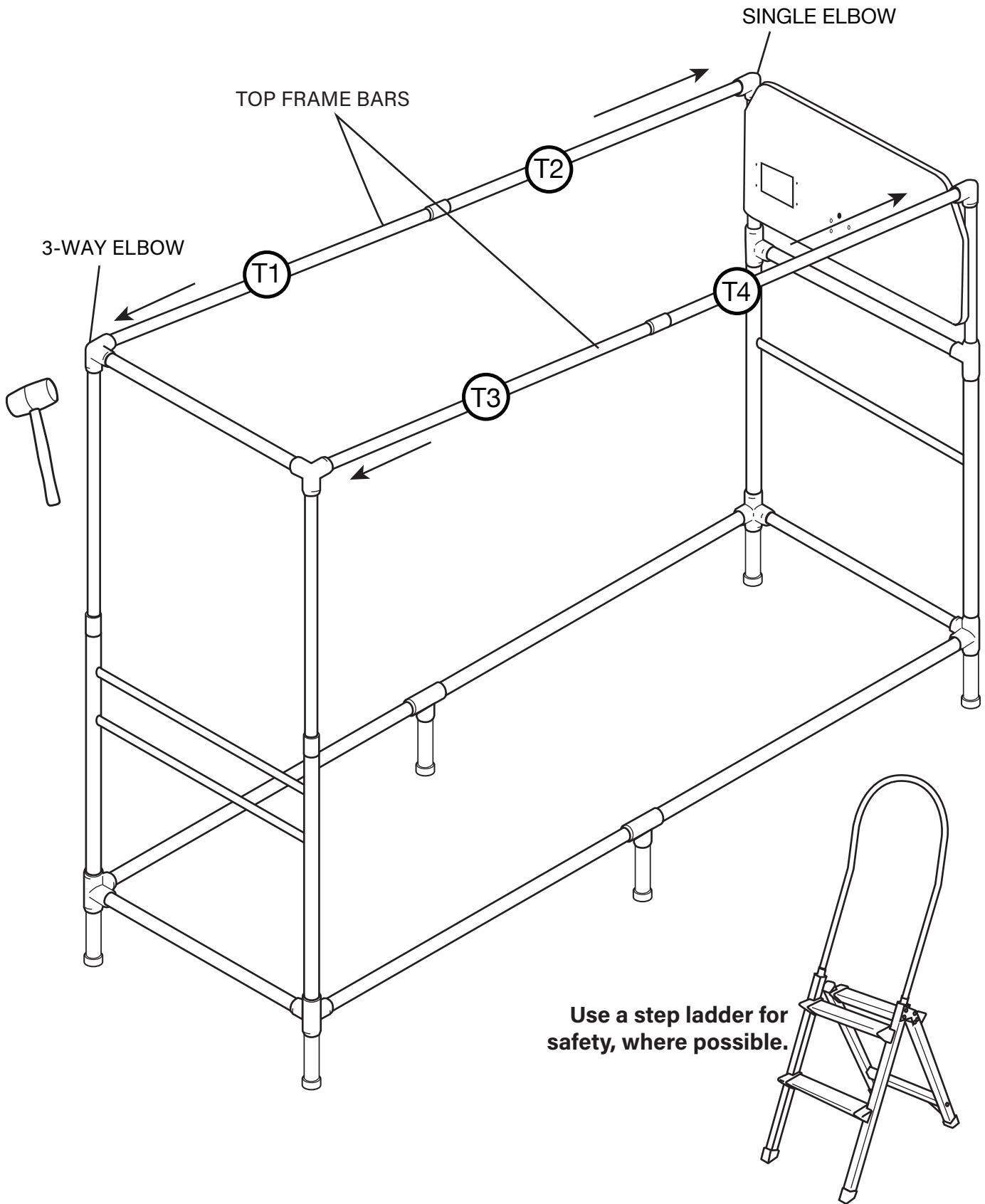



## **STEP 5**

Install Rim with hardware using the included **Nuts and Bolts**; you will need a 9/16" Wrench, a 3/8" Drive Ratchet and a 9/16" Deep Well Socket (not included).

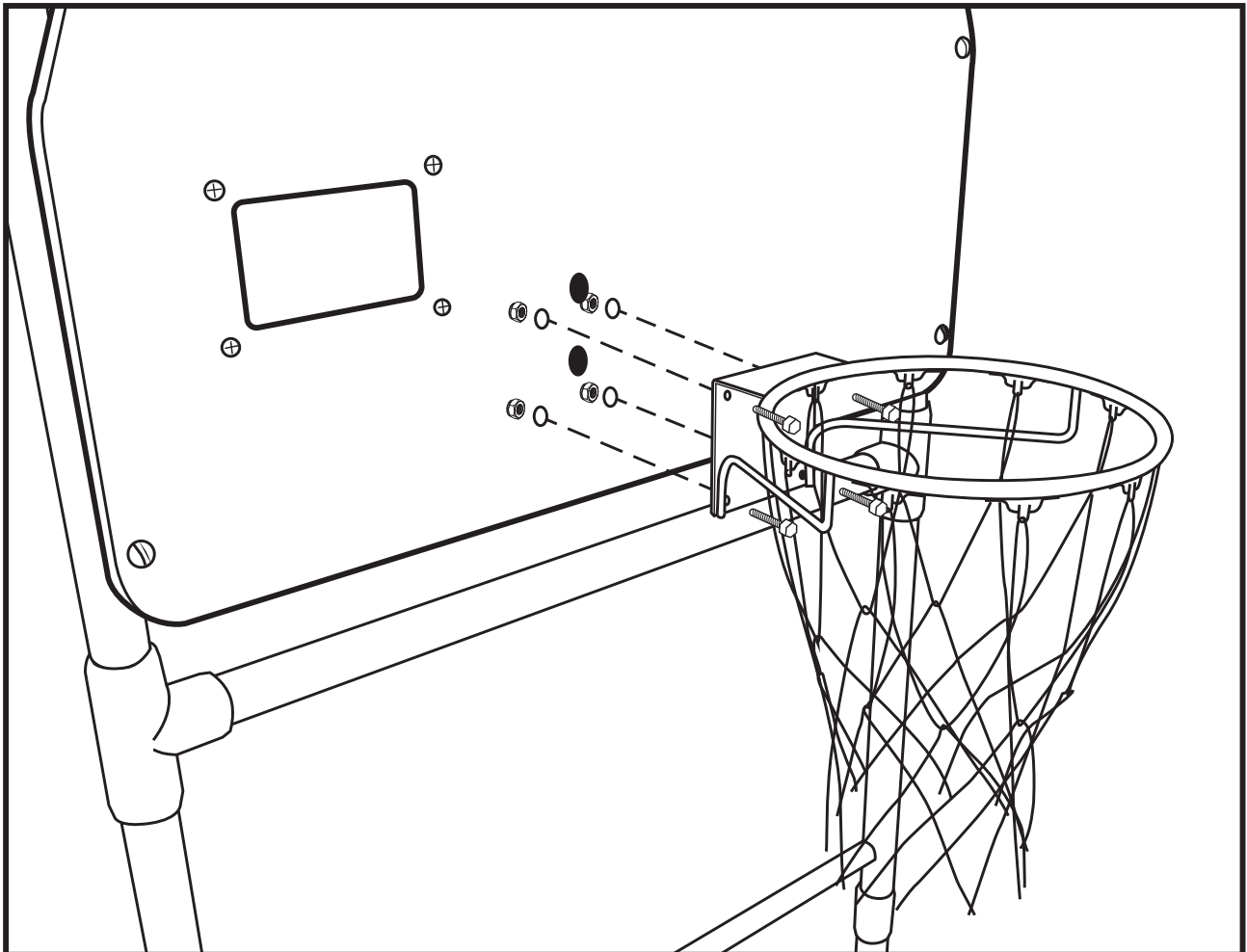

**Note:** Your sensor and scoreboard are pre-installed. Please make sure the connections are secure.

## STEP 6

Attach **Ramp side net sets** to frame. **Bungee ball cords** are included to hold the ramp to the frame. Snap the **Control Panel** onto the **Horizontal Bar (F4)**. Thread the **Control Panel** wire through the hole in the laminated **Game Operations "Cheat Sheet"** until the **Cheat Sheet** is next to the **Control Panel** (See inset).

Take the **Control Panel** wire and weave it through the side netting towards the back of the **Backboard**. Plug the **Control Panel** wire into the outlet labeled "Control Panel" in the **Scoreboard**. Plug **AC Adapter** to the **Scoreboard** and into a wall outlet. (Optional: You may use four- AA batteries (not included)). Screw **Wing Nuts** to the **Ring Tabs** to hold the **Ramp Net** to the **Backboard**.

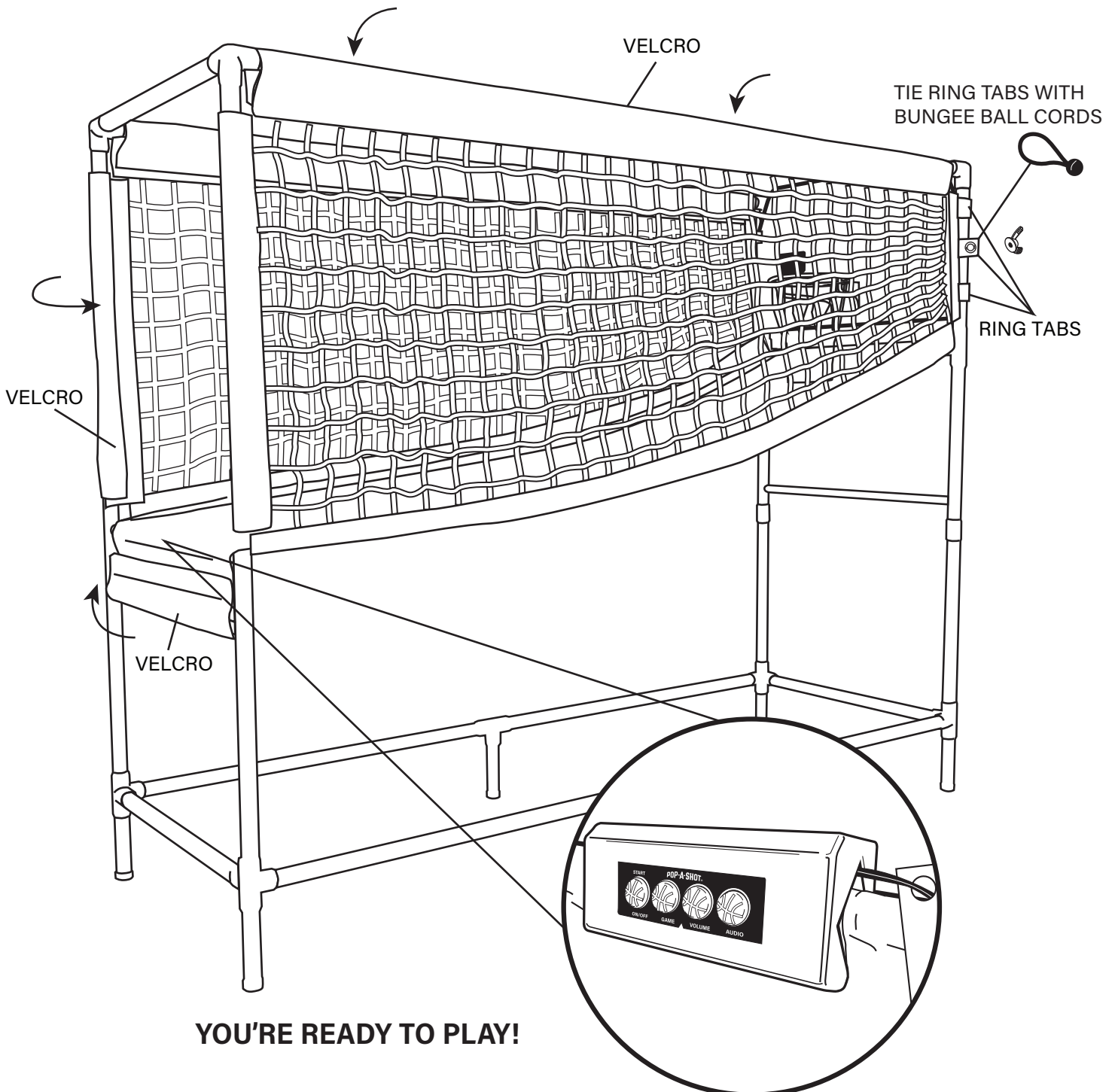

# CLASSIC POP-A-SHOT GAME OPERATION

Now that you've put your Pop-A-Shot Classic together, let's get started playing!

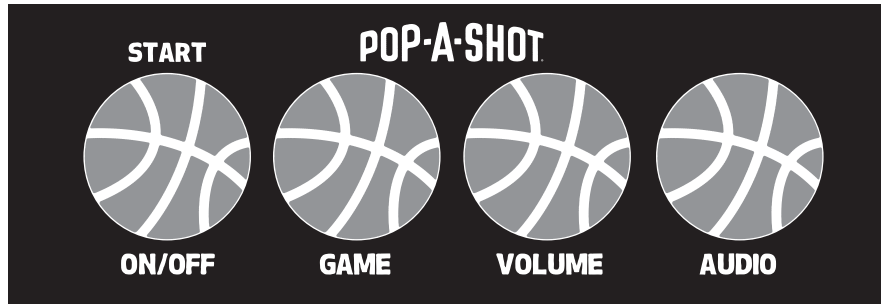

## Control Panel Operation

**Turning on the game:** Press **ON/OFF** to turn on your game.

**Select Game:** Press **GAME** to select one of the six games.

**Audio:** Press **AUDIO** to make audio selection.

**Volume:** Press **VOLUME** to turn volume up/down (it goes all the way in one direction before going back to the other).

**Note:** After the end of each game, the all time high score for that game will be displayed. If you unplug your game or take out the batteries and want to preserve the high score, make sure the other power supply is still working.

## Audio Options

There are six different audio options. Select the audio option by pushing **AUDIO** until you reach your selection (the number will be displayed on the scoreboard).

**S1:** Play-by-play announcer and Sound FX

**S2:** Sound FX only

**S3:** Electronic Music

**S4:** Rock Music

**S5:** Hip Hop Music

**S6:** No Sound

# CLASSIC POP-A-SHOT GAME OPERATION

## Game Options

**Starting a game:** Press **START** to start your game.

### 1. Standard Play

:30 on clock

Announcer and clock count down to start

Baskets are 2 points for 1st :20, then 3 points for final :10 and all bonus time

Bonus: :15 extra at 30 points; :10 extra at 60 points

### 2. Skeet Shooting

Announcers says "Shoot," then you have :03 to make a basket

### 3. Double Or Nothing:

:30 on clock

First basket counts for 2 points, then each subsequent basket counts for double

If no basket is made within :03, next basket is 2 points

### 4. Overtime:

1:00 on clock

### 5. Sudden Death:

:15 on clock

### 6. Free Play:

All baskets count as 2 points